



- ① Precautions
- ② Product Overview
- ③ Connections
- ④ Using
- ⑤ Troubleshooting
- ⑥ Other Information

LCD PROJECTOR
Owner's Instructions
SP-L250 SP-L220 SP-L200



✘ To avoid injuries or damage to property, please read the following precautions carefully and use the product accordingly.

**Warning**

Failure to follow the instructions marked with this symbol may cause personal injury or even fatality.

**Notice**

Failure to follow the instructions marked with this symbol may cause personal injury or damage to the product or property.

| [Power Related](#) | [Installation Related](#) | [Cleaning and Use Related](#) |

Power Related

[The images here are for reference only, and are not applicable in all cases (or countries).]

**Warning**

Insert the power plug firmly so that it does not come loose.

- When the connection is not firm, it may cause a fire.



Do not use loose power outlets or damaged power cables.

- There is a danger of electric shock or fire.



Under no circumstances touch the power plug with wet hands.

- There is a danger of electric shock.

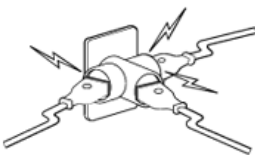

Do not plug multiple devices into a single wall outlet.

- There is a danger of fire.



Do not bend the power cord excessively or place heavy objects on it.

- There is a danger of electric shock or fire.



Before moving the product, make sure the power is off and remove the power cord from the wall outlet. In addition, make sure all connection cables are disconnected from other devices before moving it.

- Moving the product without disconnecting the power cord may damage the power cord and cause electric shock or fire.

To disconnect the apparatus from the mains, the plug must be pulled



out from the mains socket, therefore the mains plug shall be readily operable.

- There is a danger of electric shock or fire.

 **Notice**



Always unplug the unit by holding the power plug. Pulling the power cable may damage the inside of it.

- There is a danger of fire.



Unplug the power plug before cleaning the product.

- There is a danger of electric shock or fire.

| [Power Related](#) | [Installation Related](#) | [Cleaning and Use Related](#) |

 **Installation Related**

 **Warning**

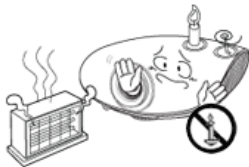

TO PREVENT THE SPREAD OF FIRE, KEEP CANDLES OR OTHER OPEN FLAMES AWAY FROM THIS PRODUCT AT ALL TIMES.

- There is a danger of fire.



When installing the product in a cabinet or on a shelf, make sure the front end of the base does not protrude.

- Dropping the product may damage it or cause injury.

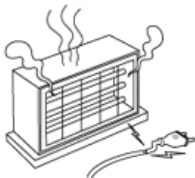

Keep the power cord away from heaters.

- The coating of the power cord may melt and cause electric shock or fire.



Do not install the product in locations exposed to oil, smoke, moisture or water (rainwater), or in a vehicle.

- There is a danger of electric shock or fire.

Do not install the product in locations with poor ventilation such as a bookshelf, closet, etc.

- An increase in the internal temperature may cause a fire.



Do not install on an unstable location, or on a stand smaller than the product.

- If the product falls it may harm children. Install on a flat and stable location as the front part is heavy.



In case of thunder/lightning, disconnect the power cord from the wall outlet.

- There is a danger of electric shock or fire.



Notice



Make sure the product's vents are not blocked by a table cloth or curtain.

- An increase in the internal temperature may cause a fire.



Place the product on the ground carefully.

- Not doing so may cause damage or injury.



Do not drop the product while carrying it.

- Doing so may cause damage or injury.



Keep the product out of children's reach.

- If the product falls it may cause harm to children. Install on a flat and stable location as the front part is heavy.

| [Power Related](#) | [Installation Related](#) | [Cleaning and Use Related](#) |

Cleaning and Use Related



Warning

Do not insert any metal objects such as a fork, chopsticks, wires, gimlets, or inflammable objects such as paper into the vents, the PC/COMPOSITE port, the Power port or the Battery port.

- This may cause electric shock or fire.
If water or an alien substance enters the product, turn the product off,



disconnect the power cord from a wall outlet and contact a **Service Center**.



Do not disassemble, or attempt to fix or modify the product.

- When the product requires repairs, contact a **Service Center**.



Do not use or keep the product near flammable sprays or other such substances.

- There is a danger of fire or explosion.



Do not place containers with water, vases, drinks, chemicals, small metal parts or heavy objects on the product.

- If water enters the product, it may cause electric shock, or fire and when heavy objects fall, they may cause injury.



Do not let children place objects such as toys or cookies on the product.

- If a child tries to reach for any of these objects, the product may fall and cause harm.

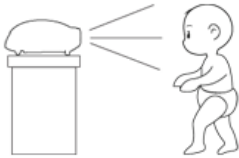

Do not look directly at the light of the lamp nor project the picture onto eyes.

- This is dangerous; especially for children.



When you remove batteries from the remote, be careful that they are not swallowed by children. Keep batteries out of the reach of children.

- If swallowed, see a doctor immediately.



If the product emits smoke, unusual noise, or there is a burning smell, disconnect the power plug immediately, and contact a Service Center.

- There is a danger of electric shock or fire.



If the power plug pin or jack is exposed to dust, water or alien substances, clean it thoroughly.

- There is a danger of electric shock or fire.

When cleaning the product, disconnect the power cord and wipe the

product using a soft dry cloth.



- Do not use any chemicals such as wax, benzene, alcohol, thinners, insecticide, air freshener, lubricant or detergent.



When not using the product for an extended period of time, disconnect the power plug.

- Otherwise, this may cause heat emission from the accumulated dirt or degraded insulation, leading to electric shock or fire.



Be sure to contact an authorized service Center, when installing your product in a location with heavy dust, high or low temperatures, high humidity, chemical substances and where it operates for 24 hours such as the airport, the train station etc.

- Failure to do so may cause serious damage to your product.



If the product is dropped or the casing is damaged, turn the product off and unplug the power cord.

- This may cause electric shock or fire. Contact a [Service Center](#).



Use only specified standard batteries. Do not use new and used batteries together.

- Incorrect polarity may cause a battery to break or leak and could lead to fire, injury, or contamination (damage).



Make sure to place your remote control on a table or desk.

- If you step on the remote control, you may fall and hurt yourself or the product may be damaged.

Correct Disposal of This Product (Waste Electrical & Electronic Equipment) - Europe only



(Applicable in the European Union and other European countries with separate collection systems)

This marking on the product, accessories or literature indicates that the product and its electronic accessories (e.g. charger, headset, USB cable) should not be disposed of with other household waste at the end of their working life. To prevent possible harm to the environment or human health from uncontrolled waste disposal, please separate these items from other types of waste and recycle them responsibly to promote the sustainable reuse of material resources.

Household users should contact either the retailer where they purchased this product, or their local government office, for details of where and how they can take these items for environmentally safe recycling.

Business users should contact their supplier and check the terms and conditions of the purchase contract. This product and its electronic accessories should not be mixed with other commercial wastes for disposal.

Correct disposal of batteries in this product - Europe only



(Applicable in the European Union and other European countries with separate battery return systems.)

This marking on the battery, manual or packaging indicates that the batteries in this product should not be disposed of with other household waste at the end of their working life. Where marked, the chemical symbols *Hg*, *Cd* or *Pb* indicate that the battery contains mercury, cadmium or lead above the reference levels in EC Directive 2006/66. If batteries are not properly disposed of, these substances can cause harm to human health or the environment.

To protect natural resources and to promote material reuse, please separate batteries from other types of waste and recycle them through your local, free battery return system.

LCD PROJECTOR
SP-L250 SP-L220 SP-L200



Product Features

01 An optical engine adopting new LCD technology

- 1024 x 768 panel has been adapted.
- Utilizes a 3P-LCD panel.
- SP-L250 : Provides a bright screen of 2500 lumen.
- SP-L220 : Provides a bright screen of 2200 lumen.
- SP-L200 : Provides a bright screen of 2000 lumen.
- Compact size, lightweight, and good portability

02 Minimized fan noise

- Minimizes the noise generated by the product's fan by optimizing the internal air flow and the fan installation structure.

03 Various input terminals

- Increases the connectivity to peripheral devices by providing various terminals, such as 2 D-Sub 15p (supporting DTV signal), S-Video, and Video terminals.

04 Audio Output

- There are two stereo speakers on the right and left and a 5-band equalizer is supported.

05 User adjustments

- This unit allows adjustment of each input port.
- The unit has a reference pattern that can be used for positioning and adjustment.

Product Views

Front/Upper Side



1. Indicators

- STAND BY (Blue LED)
- LAMP (Blue LED)
- TEMP (Red LED)

※ Refer to the [LED Indications](#).

2. VOL - / + & Select and Move Button

Adjusts the volume.
Use this button to move to or select an item within a menu.

3. MENU Button

Use this button to enter or exit a menu or to move forward in a menu.

4. SOURCE Button

Used to select input signals from the external sources.

5. POWER(⏻) Button

Used to turn the projector on or off.

6. Lens

7. Remote Control Signal Receiver

8. Focus Ring

Used for Focus Adjustment.

9. Zoom Knob

Used to enlarge or reduce image size.

10. Lens cover

2 Unpacking

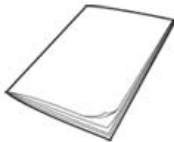

Quick Installation Guide / Safety Guide



Warranty Card/ Registration Card
(Not available in all locations)



User Manual CD



Power Cable

Remote Control/ 1 Batteries (CR2025)
(Not available in all locations)

Cleaning Cloth



D-Sub Cable

LED Indications

● :Light is On ◐ :Light is Blinking ○ :Light is Off

STAND BY	LAMP	TEMP	Information
●	○	○	If you press the POWER button on the remote control or projector, the screen appears within 30 seconds.
●	●	○	The projector is in normal operating condition.
●	◐	○	This state appears when the projector is preparing an operation after the POWER button on the projector or the remote control has been pressed.
○	◐	○	The POWER button is pressed to turn off the projector, and the cooling system is in operation to cool off the inside of the projector. (Operates for about 30 seconds.)
◐	○	◐	Refer to Action 1 below if the cooling fan inside the projector is not in normal operation condition.
○	◐	◐	Refer to Action 2 below if the lamp cover protecting the lamp unit is not closed properly.
●	◐	◐	This indicates that the lens cover does not open completely. Refer to Action 3 below.
●	●	◐	This indicates that it has changed to Cooling mode, because the internal temperature of the projector has increased beyond the maintenance limit. Refer to Action 4 below.
○	○	◐	This indicates that the power is turned off automatically because the internal temperature of the projector has increased beyond the maintenance limit. Refer to Action 5 below
◐	◐	◐	A problem has occurred with the operation of the lamp. Refer to Action 6.

Clearing Indicator Problems

Classification	State	Measures
Action 1	When the cooling fan system is not in normal operating condition.	If the symptom remains even after disconnecting and then reconnecting the power cord and turning the projector on again, contact your product provider or our service center .
Action 2	When the lamp cover protecting the lamp unit is not properly closed or the sensor system is not in normal operating condition.	Check if the screws on the side of the projector are correctly locked, and if they are locked normally, contact your product distributor or a service center .
Action 3	The status that the lens cover is not open completely.	Open the lens cover completely. If the lens cover is not open completely while operating the projector, both the video and audio are turned off automatically. If this status persists for ten minutes, the projector is turned off automatically.
		If the internal temperature of the projector has increased beyond the maintenance limit, it is changed to Cooling mode before it is turned off

Action 4	This indicates that it has changed to Cooling mode, because the internal temperature of the projector has increased beyond the maintenance limit.	<p>automatically.</p> <p>* Cooling mode: The fan speed has increased and the projector lamp has been changed to ECO mode.</p> <p>Check whether the ventilating hole of the projector is blocked.</p> <p>Check the air filter and clean if blocked.</p> <p>Check whether the surrounding temperature of the projector is higher than the standard temperature range of the projector.</p> <p>Cool the projector sufficiently and operate it again.</p>
Action 5	If the internal temperature of the projector increases higher than the limit, it is turned off automatically.	<p>Check whether the ventilating hole of the projector is blocked.</p> <p>Check the air filter and clean if blocked.</p> <p>Check whether the surrounding temperature of the projector is higher than the standard temperature range of the projector.</p> <p>Cool the projector sufficiently and operate it again.</p> <p>If the same problem occurs continually, contact your product distributor or service center.</p>
Action 6	The lamp malfunctions after power turns off abnormally or after powering on right after turning off the projector.	<p>Turn the power off, wait for a sufficient amount of cooling time and then turn the power on to operate. If the same problem occurs continually, contact your product distributor or service center.</p>



This Projector uses a cooling fan system to keep the unit from overheating. Operation of the cooling fan may cause noise, which does not affect the product performance and is part of normal operation.

2 Rear Side

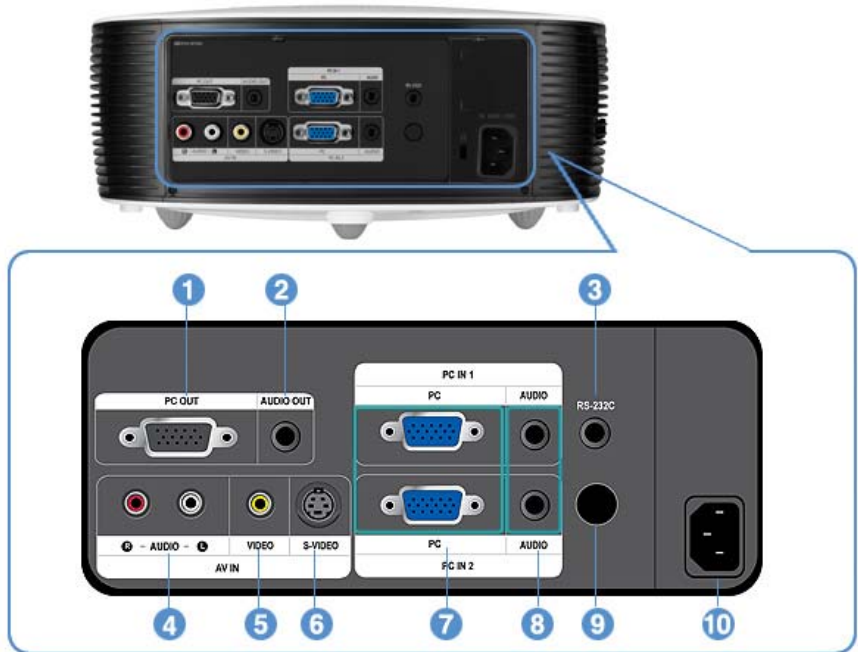

- | | |
|---|-----------------------------------|
| 1. PC OUT port | 6. [AV IN] S-VIDEO Input port |
| 2. AUDIO OUT port | 7. [PC IN1,2] PC Input port |
| 3. RS-232C port (For service input terminals) | 8. [PC IN1,2] AUDIO Input port |
| 4. [AV IN] R-AUDIO-L Input port | 9. Remote Control Signal Receiver |
| 5. [AV IN] VIDEO Input port | 10. POWER Input port |

Remote Control

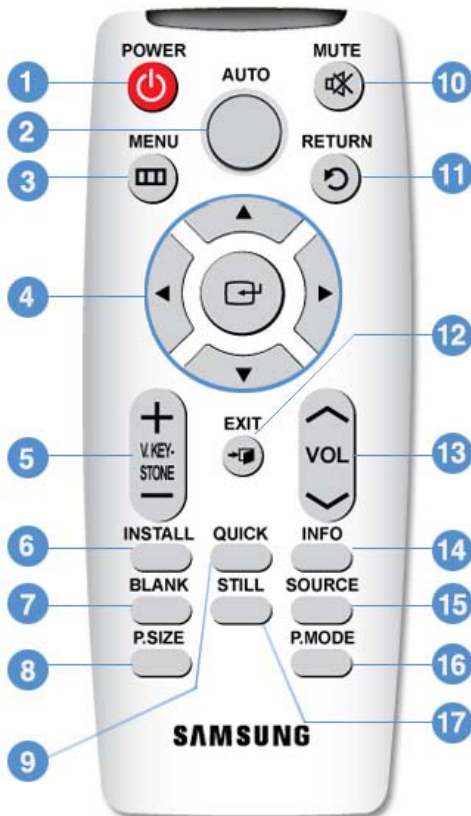

1. POWER (🔌) Button
2. AUTO Button
3. MENU (📄) Button
4. Move (⬆️ ⬇️ ⬇️ ⬆️) / (🏠) Button
5. V.KEYSTONE(+/-)
(VERTICAL KEYSTONE)Button
6. INSTALL Button
7. BLANK Button
8. P.SIZE Button
9. QUICK utton
10. MUTE (🔇) Button
11. RETURN (🔄) Button
12. EXIT (←) Button
13. VOL Button
14. INFO Button
15. SOURCE Button
16. P.MODE Button
17. STILL Button

1. POWER (🔌)

Used to turn on the projector.

2. AUTO

Adjusts the Picture automatically. (Available in PC Mode Only)

3. MENU (📄)

Used to display Menu Screen.

4. Move (⬆️ ⬇️ ⬇️ ⬆️) / (🏠)

Used to move to or select each menu item.

5. V.KEYSTONE(VERTICAL KEYSTONE) (+/-)

Use this when video scenes are distorted or tilted.

6. INSTALL

Used to flip or reverse the projected image.

7. BLANK

This is used to turn off the video and audio temporarily.

The video and audio will come back on when any button other than the POWER button is pressed.

8. P.SIZE

Used to adjust the size of the picture screen.

9. QUICK

This is used to quickly return to the last menu used.

10. MUTE)

This is used to temporarily mute the sound.

To hear sound again, press the MUTE button again or press the - VOL + button.

11. RETURN)

Returns to the previous menu.

12. EXIT)

Used to make Menu Screen disappear.

13. VOL

Adjusts the volume.

14. INFO

Used to check source signals, picture setup, PC screen adjustment and lamp lifespan.

15. SOURCE

This is used to switch between the TV and the external input.

16. P.MODE

Used to select Picture Mode.

17. STILL

Used to see still images.

[Product Features](#) | [Product Views](#) | [Remote Control](#) | [Product Specifications](#)

Product Specifications

Design and specifications of the product may be modified without prior notice for better performance.

Specifications

Model	SP-L250, SP-L220, SP-L200	
Panel	0.63" 3P LCD	
Resolution	XGA (1024 x 768)	
Aspect ratio	4:3	
Brightness	Max 2,500 ANSI lumen (L250) Max 2,200 ANSI lumen (L220) Max 2,000 ANSI lumen (L200)	
Contrast	Max 500:1	
Diagonal screen size	40 ~ 300"	
Projection Range	1 m ~ 10 m	
Zoom Adjustment	Manual	
Focus Adjustment	Manual	
Lens	F=1.65~1.93, f=18.5mm~22.5mm	
Zoom Ratio	1:1.2	
Keystone	Vertical (±20°)	
Lamp	Power Consumption	203W (Eco : 172W)
	Life Time	2,500 Hours (Eco : 3,000 Hours)
Input Terminal	D-Sub 15p x 2	Analog RGB, analog YPbPr
	Mini DIN x 1	S-Video

Speaker	RCA x 1	Composite video
		3W x 2 (Stereo)
Power	Power Consumption	Max 280 W
	Voltage	100~240V AC, 50/60Hz
Noise		Eco : 30dB, Bright : 32dB
Dimensions		291(W) x 289(D) x 127(H)
		11.5 inches(W) x 11.4 inches(D) x 5 inches(H)
Weight		3.8 Kg / 8.4 lb
User Environment	Operating	Temperature : 41 °F ~ 95 °F (5 °C ~ 35 °C), Humidity : 20 % ~ 80 % ((Non-condensing))
	Storage	Temperature : -14 °F ~ 140 °F (-10 °C ~ 60 °C) Humidity : 10 % ~ 90 % (Non-condensing)



This Class B equipment is designed for home and office use. The equipment has been registered regarding EMI for residential use. It may be used in all areas. Class A is for office use. Class A is for business while class B emits less electromagnetic waves than class A.



The LCD panel used in the LCD projector consists of hundreds of thousands of fine pixels. Like other video display devices, the LCD panel may contain bad pixels which do not operate. When shipping a product, the conditions for identifying bad pixels and the number of bad pixels that a LCD panel is allowed to contain are strictly managed in accordance with the relevant specified standards by the LCD panel manufacturer and our company. Though a screen may have some dead pixels, this does not affect the overall screen quality and the lifetime of the product.

Supported Display Modes

PC Timing

Format	Resolution		Horizontal Frequency (kHz)	Vertical Frequency (Hz)	Pixel Frequency (MHz)
IBM	640 x 350	70Hz	31.469	70.086	25.175
IBM	640 x 480	60Hz	31.469	59.940	25.175
IBM	720 x 400	70Hz	31.469	70.087	28.322
VESA	640 x 480	60Hz	31.469	59.940	25.175
MAC	640 x 480	67Hz	35.000	66.667	30.240
VESA	640 x 480	70Hz	35.000	70.000	28.560
VESA	640 x 480	72Hz	37.861	72.809	31.500
VESA	640 x 480	75Hz	37.500	75.000	31.500
VESA	720 x 576	60Hz	35.910	59.950	32.750
VESA	800 x 600	56Hz	35.156	56.250	36.000
VESA	800 x 600	60Hz	37.879	60.317	40.000
VESA	800 x 600	70Hz	43.750	70.000	45.500
VESA	800 x 600	72Hz	48.077	72.188	50.000
VESA	800 x 600	75Hz	46.875	75.000	49.500
MAC	832 x 624	75Hz	49.726	74.551	57.284
VESA	1024 x 768	60Hz	48.363	60.004	65.000
VESA	1024 x 768	70Hz	56.476	70.069	75.000
VESA	1024 x 768	72Hz	57.672	72.000	78.434
VESA	1024 x 768	75Hz	60.023	75.029	78.750
VESA	1152 x 864	60Hz	53.783	59.959	81.750
VESA	1152 x 864	70Hz	63.000	70.000	96.768
VESA	1152 x 864	72Hz	64.872	72.000	99.643
VESA	1152 x 864	75Hz	67.500	75.000	108.000
VESA	1280 x 720	60Hz	44.772	59.855	74.500
VESA	1280 x 720	70Hz	52.500	70.000	89.040
VESA	1280 x 720	72Hz	54.072	72.000	91.706
VESA	1280 x 720	75Hz	56.456	74.777	95.750
VESA	1280 x 768	60Hz	47.776	59.870	79.500
VESA	1280 x 768	75Hz	60.289	74.893	102.250
VESA	1280 x 800	60Hz	49.702	59.810	83.500
VESA	1280 x 800	75Hz	62.795	74.934	106.500
VESA	1280 x 960	60Hz	60.000	60.000	108.000

VESA	1280 x 960	70Hz	69.930	70.000	120.839
VESA	1280 x 960	72Hz	72.072	72.000	124.540
VESA	1280 x 960	75Hz	75.231	74.857	130.000
VESA	1280 x 1024	60Hz	63.981	60.020	108.000
VESA	1280 x 1024	70Hz	74.620	70.000	128.943
VESA	1280 x 1024	72Hz	76.824	72.000	132.752
VESA	1280 x 1024	75Hz	79.976	75.025	135.000
VESA	1400 x 1050	60Hz	65.317	59.978	121.750
VESA	1440 x 900	60Hz	55.935	59.887	106.500
VESA	1440 x 900	75Hz	70.635	74.984	136.750
VESA	1600 x 1200	60Hz	75.000	60.000	162.000



For the resolutions presented above, if a signal with a resolution lower or higher than 1024x768 is input, it is converted to 1024x768 by the Scaler chip inside the projector.
When the real resolution (1024x768) of the projector and the PC output resolution are the same, the screen quality is optimal.

◇ AV Timing (D-Sub)

Format	Resolution		Scan
	Resolution	Frequency	
BT.601 SMPTE 267M	480i	59.94Hz	Interlaced
BT.1358 SMPTE 293M	480p	59.94Hz	Progressive
BT.601	576i	50Hz	Interlaced
BT.1358	576p	50Hz	Progressive
SMPTE 296M	720p	59.94Hz/60Hz	Progressive
	720p	50Hz	Progressive
BT.709 SMPTE 274M	1080i	59.94Hz/60Hz	Interlaced
	1080i	50Hz	Interlaced

◇ AV Timing (VIDEO/S-VIDEO)

NTSC, NTSC 4.43, PAL, PAL60, PAL-N, PAL-M, SECAM

LCD PROJECTOR
SP-L250 SP-L220 SP-L200



Basic Settings

▶ Installing the Projector

Install the projector so that the beam from the projector is perpendicular to the screen.



Place the projector so that the lens is at the center of the screen.

If the screen is not vertically installed, the picture on the screen may not be a rectangle.

Do not install the screen in bright surroundings. If the screen is too bright, the picture on the screen will not be displayed clearly.

When installing the screen in bright surroundings, use curtains.

You can install the projector in the following locations: Front-Floor / Front-Ceiling / Rear-Floor / Rear-Ceiling.

([To view the installation position settings](#))

01 To view the picture when installing the projector behind the screen,

Install a semi-transparent screen.

Select [Menu > Setup > Install > Rear-Floor](#)



02 To view the picture when installing the projector in the front of the screen,

Install the projector at the side where you are watching the screen.

Select [Menu > Setup > Install > Front-Floor](#)



▶ Zoom and Focus Adjustment



1 Zoom Knob 2 Focus Ring

01 You can adjust the size of image within zoom range by manipulating the Zoom Knob.

02 Focus the picture on the screen using the Focus Ring.



⤵ If your product is installed at a location out of the specified projection distance (refer to [Screen Size and Projection Distance](#)), the focus cannot be adjusted correctly.

▶ Leveling with Adjustable Feet



For level placing of the projector, adjust the Adjustable Feet of the projector.



⤵ The projector can be adjusted to a height of up to 30 mm (about 12 °) from the reference point.

⤵ Depending on the position of the projector, Keystone distortion of the image may appear. If a keystone occurs, adjust it using the [V-Keystone](#) function.

▶ Screen Size and Projection Distance

Install the projector on a flat, even surface and level the projector using the adjustable feet to realize optimal picture quality. If images are not clear, adjust them using the Zoom Knob or Focus Ring, or move the projector forward and backward.

Screen size (M:inch)	Horizontal (X:mm)	Vertical (Y:mm)	Max (Z:mm)	Min (Z:mm)	Offset (Y':mm)
40	812.8	609.6	1376	1140	102
50	1016.0	762.0	1727	1433	127
60	1219.2	914.4	2078	1726	152
70	1422.4	1066.8	2430	2020	178
80	1625.6	1219.2	2781	2313	203
90	1828.8	1371.6	3133	2606	229
100	2032.0	1524.0	3484	2899	254
110	2235.2	1676.4	3835	3192	279
120	2438.4	1828.8	4187	3485	305
130	2641.6	1981.2	4538	3778	330
140	2844.8	2133.6	4889	4071	356
150	3048.0	2286.0	5241	4364	381
160	3251.2	2438.4	5592	4657	406
170	3454.4	2590.8	5944	4950	432
180	3657.6	2743.2	6295	5243	457
190	3860.8	2895.6	6646	5536	483
200	4064.0	3048.0	6998	5829	508
210	4267.2	3200.4	7349	6122	533
220	4470.4	3352.8	7701	6415	559
230	4673.6	3505.2	8052	6708	584
240	4876.8	3657.6	8403	7001	610
250	5080.0	3810.0	8755	7294	635

260	5283.2	3962.4	9106	7587	660
270	5486.4	4114.8	9457	7880	686
280	5689.6	4267.2	9809	8173	711
290	5892.8	4419.6	10160	8466	737
300	6096.0	4572.0	10512	8759	762



➤ This projector is designed to show images optimally on a 80 – 120 inch sized screen.

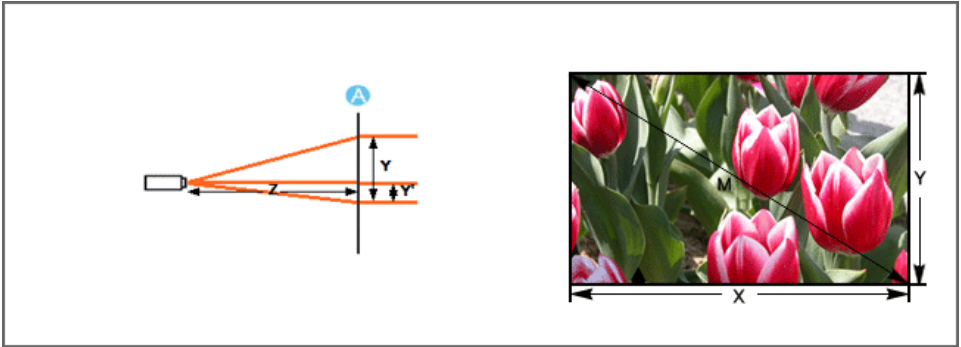

A. Screen



➤ Z: Throw Distance

➤ Y': Distance from Lens Center to Image Bottom

➤ Setting up the PC Environment - Check the following items before connecting your PC to your projector.

1. Click the right mouse button on the Windows desktop and click on [Properties].
<Display Properties> tab will appear.
2. Click on [Settings] tab and set the <Screen resolution> by referring to <Resolution> as described in [the display mode table supported](#) by this projector.
You do not have to change <Color quality> setup.
3. Press the [Advanced] button.
Another property window will appear.

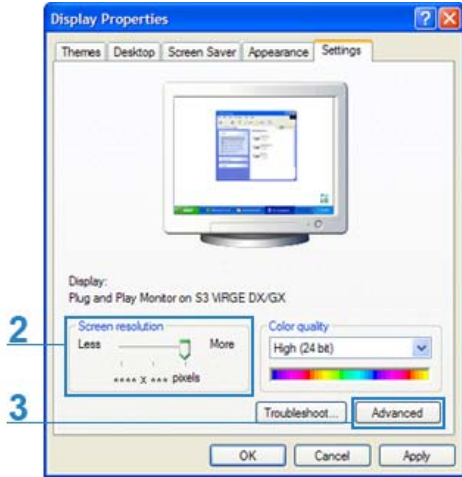

- Click on [Monitor] tab and set the <Screen refresh rate> by referring to <Vertical Frequency> as described in [the Supported Resolution/Size Modes table](#).



- Click the [OK] button to close the window, and click the [OK] button of the <Display Properties> window to close the window.
The computer may restart automatically.

- Shut down the PC and connect to the projector.

Process might vary depending on your type of computer or Windows versions.
(For example, [Properties] appears instead of [Properties (R)] as shown in 1.)



- ◆ This unit appliance supports up to 24 bits per pixel in Color quality when it is used as a PC monitor.
- ◆ Projected images may differ from the monitor depending on monitor manufacturer or Windows versions.
- ◆ When connecting the projector to a PC, check that PC setup complies to display settings supported by this projector. If not, there may be signal problems.
- ◆

| [Basic Settings](#) | [Connecting the Power](#) | [Connecting an External Device](#) |

Connecting the Power

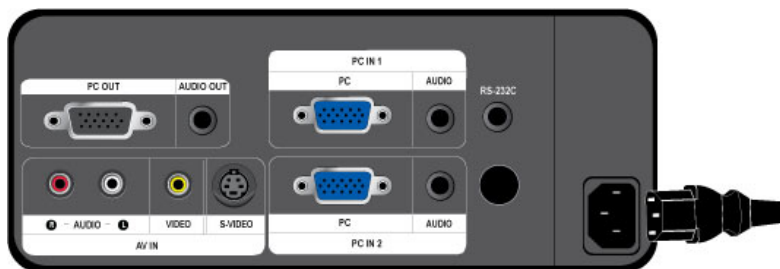

1. Rear of Projector

- Plug the power cord into the power terminal on the rear side of the projector.

| [Basic Settings](#) | [Connecting the Power](#) | [Connecting an External Device](#) |

Connecting an External Device

▶ Connecting a PC using a D-Sub cable

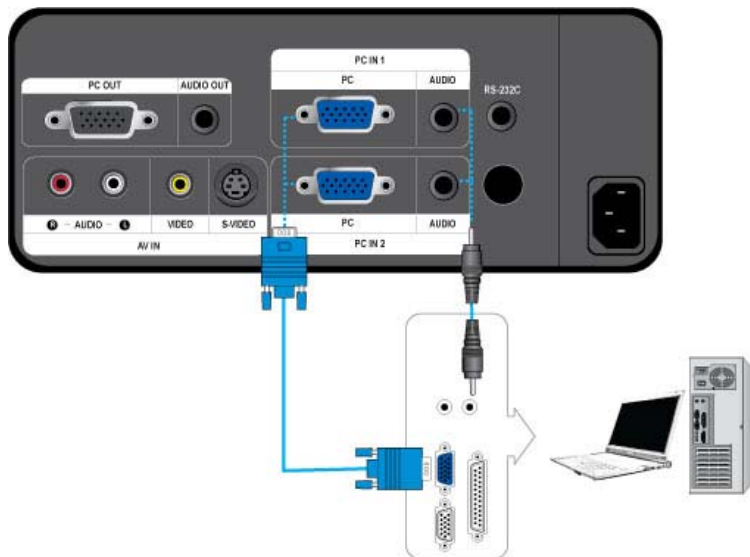

⚡ Check that your PC and projector are turned off.

01 Connect the [PC IN (1 or 2) PC] terminal at the back of the projector to the D-Sub terminal of your PC using a D-Sub cable.

- For the supported input signals, refer to "[PC Timing](#)".

02 Connect the [PC IN (1 or 2) AUDIO] terminal at the back of the projector to the Audio out terminal of your PC using an audio cable (Not supplied).

▶ Connecting an External Monitor

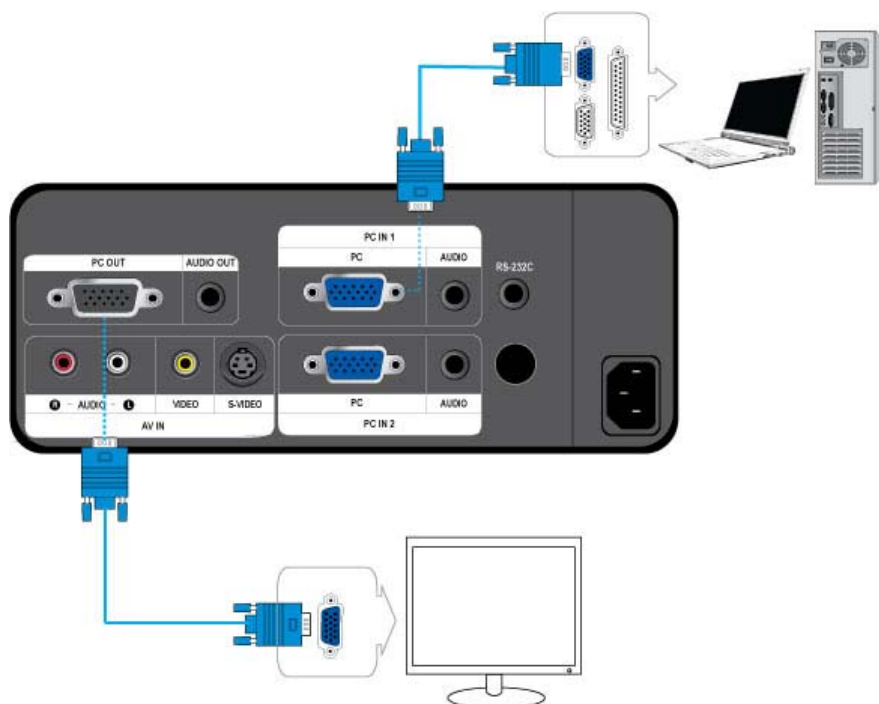

⚡ You can view an image on both your projector and a separate monitor at the same time.

⚡ Check that your PC and projector are turned off.

01 Connect the [PC IN (1) PC] terminal at the back of the projector to the D-Sub terminal of your PC using a D-Sub cable.

02 Connect the [PC OUT] terminal of the projector to the D-Sub terminal of a monitor using a D-Sub cable.

- When connecting a monitor using the [PC OUT] function, make sure to connect your PC to the [PC IN (1) PC] terminal.

- The monitor output which is connected to the [PC OUT] terminal will be normal even if you see a blank screen on your projector.

- The [PC OUT] function also operates in standby mode.

▶ Connecting an AV device using a D-Sub cable

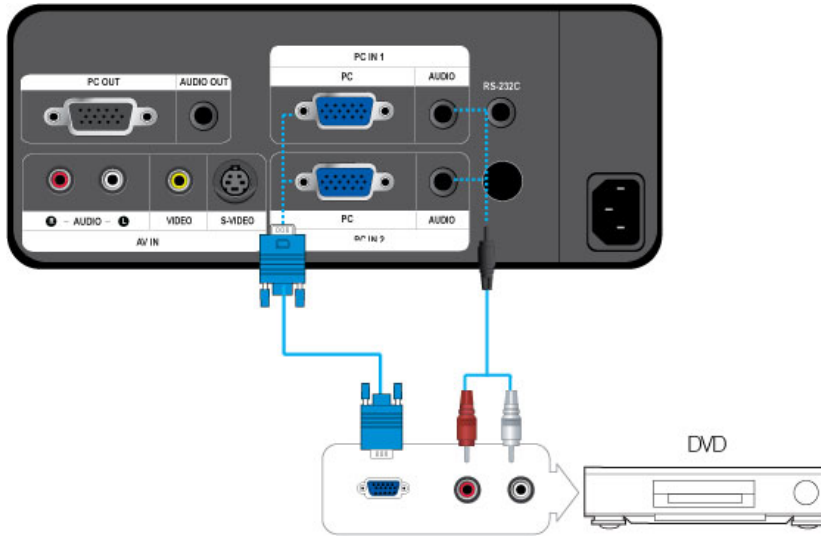

⚡ First, check that the AV device and your projector are turned off.

0.1 Connect the [PC IN (1 or 2) PC] terminal at the back of the projector to the D-Sub terminal of your AV device using a D-Sub cable.

- For supported input signals, refer to the "[AV Timing \(D-Sub\)](#)".

0.2 Connect the [PC IN (1 or 2) AUDIO] terminal at the back of the projector to the Audio out terminal of your AV device using an audio cable (Not supplied).

▶ Connecting an AV device with component output

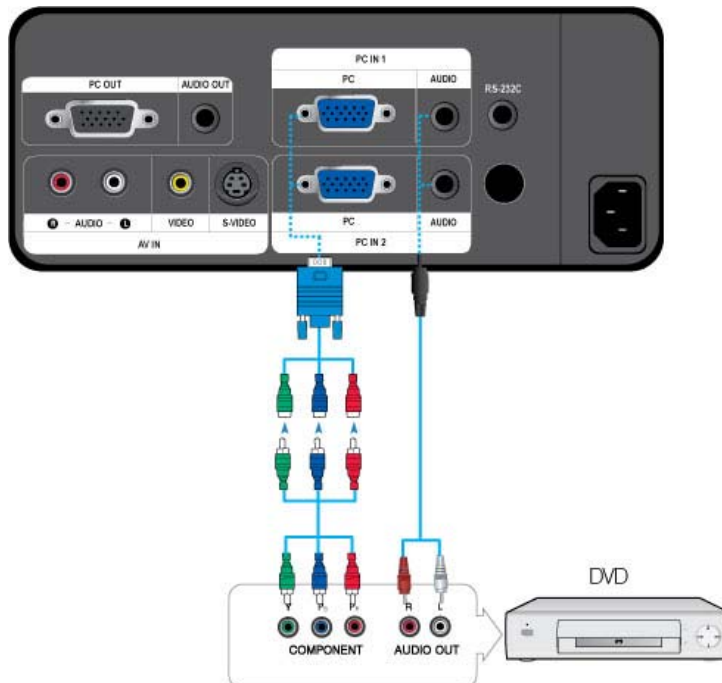

⚡ First, check that the AV device and your projector are turned off.

0.1 Connect the [PC IN (1 or 2) PC] terminal at the back of the projector to the Component terminal of your AV device using a D-Sub/Component cable (Not supplied).

- For supported input signals, refer to the "[AV Timing\(D-Sub\)](#)".

- 02 Connect the [PC IN (1 or 2) AUDIO] terminal at the back of the projector and the Audio out terminal of your AV device using an audio cable (Not supplied).

2 Connecting using a Video/S-Video cable

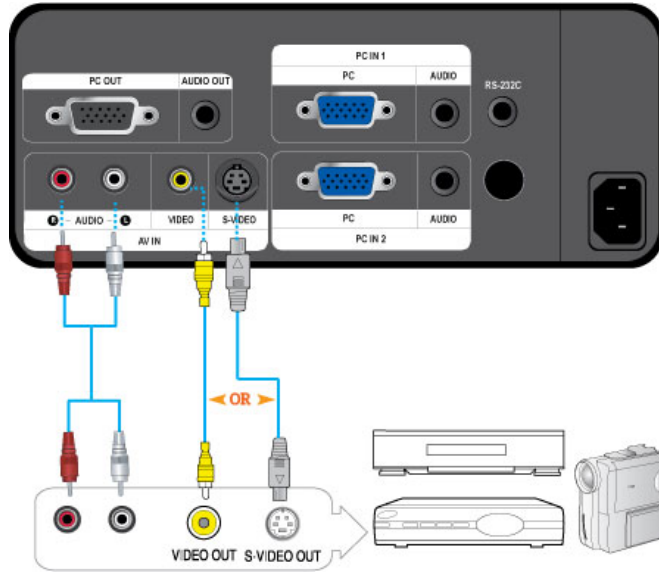

◇ First, check that the AV device and your projector are turned off.

- 01 Connect the [VIDEO] or [S-VIDEO] terminal and the AV device using a Video cable (Not supplied) or S-Video cable (Not supplied).

- For supported input signals, refer to the "[AV Timing\(VIDEO/S-VIDEO\)](#)".

- 02 Connect the [AV IN R-AUDIO-L] terminal at the back of the projector and the Audio out terminal of your AV device using an audio cable (Not supplied).

2 Connecting an External Speaker



◇ You can hear sound through an external speaker instead of the internal speaker embedded in the projector.

- 01 Prepare an audio cable (Not supplied) suitable for your external speaker.

- 02 Connect the [AUDIO OUT] terminal of the projector to the external speaker using an audio cable.

- When using an external speaker, the internal speaker does not operate, but you can adjust the volume of the external speaker using the Volume button of the projector (or remote control).

- The [AUDIO OUT] terminal can output all audio signals.

LCD PROJECTOR

SP-L250 SP-L220 SP-L200



Basic Functions

Turning on the projector

- ◇ Check that the lens cover is opened completely.
- ◇ Turn the power on.
- ◇ Check that the STAND BY LED indicator is turned on.
- ◇ Press the Power button. While the power is turned on (with the Power button on the remote control or at the top of the projector), the blue LAMP LED indicator blinks.

When the power is turned on completely, the LAMP LED indicator remains blue.



If the projector is turned on when the lamp is not sufficiently cooled, a temporary loud noise may be heard because the fan speed increases to cool the lamp.

Turning off the projector

- ◇ Press the Power button. (With the remote control or on top of the projector) OK or Cancel is displayed. Select OK using the arrow keys (With the remote control or on top of the projector). Press the Enter button or press the Power button again.
- ◇ The STAND BY LED indicator is turned off and the LAMP LED indicator blinks. The fan speed increases to cool the lamp quickly. When the operation is finished, the LAMP LED indicator is turned off and the STAND BY LED indicator is turned on and remains blue.
- ◇ Remove the power cord.
- ◇ Close the lens cover.



Selecting an input source

- ◇ Press the SOURCE button (on the remote control or at the top of the projector).
- ◇ AV and S-Video modes can only be selected when an external device is connected. PC1 and PC2 modes can be selected regardless of an external device being connected.

Input



* Click the Play(▶)/Stop(◻) button in the table below to view the video file.

Screen Adjustment	Description	Play/Stop	
Source List	You can select a device connected to the projector to display.		
	1) PC 1	3) AV	
	2) PC 2	4) S-Video	
	Edit Name	You can edit the names of devices connected to the projector.	
1) VCR		7) DVD Receiver	
2) DVD		8) Game	
3) Cable STB		9) Camcorder	
4) HD STB		10) DVD Combo	
5) Satellite STB		11) PC	
6) AV Receiver			

| [Basic Functions](#) | [Input](#) | [Picture](#) | [Setup](#) | [Option](#) |

Picture



* Click the Play(▶)/Stop(◻) button in the table below to view the video file.

Screen Adjustment	Description	Play/Stop	
Mode	Select a screen state which is customized to your projector or change the screen mode as required.		
	1) Mode		
	- Standard	This picture mode is the most general mode and works well in most situations.	 Mode
	- Presentation	This mode is suitable for presentations.	
	- Text	This mode is suitable for text work.	
	- Movie	This mode is suitable for viewing a movie.	
	- Game	This picture mode is optimized for playing games. ▶ The text in a still picture may be displayed unnaturally.	
	- User		

This mode is a customized mode created using the **Mode > Save** function.

► **Presentation and Text modes are only enabled if the input signal is a PC Timing signal.**

2) **Contrast** : Used to adjust the contrast between the object and the background.

3) **Brightness** : Used to adjust brightness of the entire picture.

4) **Sharpness** : Used to adjust the sharpness of the picture.

► **When the input signal is PC Timing, the Sharpness cannot be adjusted.**

5) **Color** : Used to adjust color lighter or darker.

► **When the input signal is PC Timing, the Color cannot be adjusted.**

6) **Tint** : Used to obtain more natural color of objects using Green or Red enhancement.

► **When the input signal is PC Timing and PAL and SECAM of the [S-Video] and [AV] modes, the color cannot be adjusted.**

7) **Color Temperature** : You can select the color temperature according to your preferences.

- Factory defaults: 5500K, 6500K, 8000K, 9300K

- You can select the color temperature for the items below according to your preferences.

R-Gain, G-Gain, B-Gain : Adjusts the color temperature of the White level.

R-Offset, G-Offset, B-Offset : Adjusts the color temperature of the Black level.

1) **Color Temperature**

5) **R-Offset**

2) **R-Gain**

6) **G-Offset**

3) **G-Gain**

7) **B-Offset**

4) **B-Gain**

8) **Gamma** : Changes the brightness characteristic for each color tone of an image.

- The larger (+) the value, the greater the contrast of the bright and dark parts; the smaller (-) the value, the darker the dark parts.

- Adjustable range: -3 to +3

9) **Save** : You can save the status of a screen you adjusted according to your preferences using the **Mode > User** OSD.

10) **Reset** : Restores the mode settings to the factory defaults.

Size You can select a screen size according to the type of scene.

► **When the input signal is PC Timing, Zoom1/Zoom2 is not supported.**

1) **Normal**

2) **Zoom1**

3) **Zoom2**

4) **16:9**

Position Adjust the screen position if it is not aligned.

Digital NR When a dotted line is displayed or the screen shakes, you can view a better visual quality picture by enabling Noise Reduction.

► **When the input signal is PC Timing, Digital NR does not operate.**

Black Level You can select the signal black level according to the input signal. If it is unsuitable for the input signal, the dark parts may not be shown clearly or may be dim.

► **The Black level can only be set for the 480i and 576i RGB signals of [AV], [S-Video] and AV Timing(D-Sub) modes.**





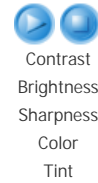

- For [AV],[S-Video] and the 480i and 576i signals of **AV Timing(D-Sub)**.

1) **0 IRE** : Sets the black level to 0 IRE

2) **7.5 IRE** : Sets the black level to 7.5 IRE

Overscan Using this function, you can cut the edge of the picture when unnecessary information, images appear on the edge of the picture.





	<p>▶ This is not supported in [AV] and [S-Video] modes.</p> <p>▶ This is supported only when the input signal is AV Timing(D-Sub) .</p> <p>▶ If Overscan is turned off, unnecessary extra parts at the edges of an image may also be shown, though you can view more of the area.</p> <p>In this case, turn Overscan on.</p>	
Film Mode	<p>Using this function, you can set the display mode so it is optimized for playing movies.</p> <ol style="list-style-type: none"> 1) Off 2) On <p>▶ Film Mode can only be supported for the [AV], [S-Video], 480i, and 576i of AV Timing(D-Sub) signals .</p>	
PC	<p>Eliminates or reduces noise that causes unstable screen quality, such as screen shaking. If the noise is not removed using Fine Adjustment, adjust the frequency to the maximum and then perform Fine Adjustment again.</p> <p>▶ It is only enabled for the PC Timing input of the D-Sub terminal.</p> <p>▶ Refer to PC Timing.</p> <ol style="list-style-type: none"> 1) Auto Adjustment : Used to adjust frequency and phase of PC screen automatically. 2) Coarse : Used to adjust frequency when vertical lines appear on PC screen. 3) Fine : Used to fine tune the PC screen. 4) Reset : Using this function, you can reset the PC menu settings to the factory default settings. 	 Auto Adjustment  Coarse  Fine  Reset
Zoom	<p>Enlarges the PC screen to 2X, 4X, or 8X.</p> <p>▶ This can only be adjusted when the input signal is PC Timing.</p>	

Setup



* Click the Play(▶)/Stop(◻) button in the table below to view the video file.

Screen Adjustment	Description	Play/Stop
Install	<p>To tailor the picture to the installation location, you can invert the projected images vertically/horizontally.</p> <ol style="list-style-type: none"> 1) Front-Floor : Normal Image 2) Front-Ceiling : Horizontal/Vertical Reversed Image 3) Rear-Floor : Horizontally Reversed Image 4) Rear-Ceiling : Vertically Reversed Image 	
Lamp Mode	<p>Used to set the image brightness by adjusting the amount of light generated by the lamp.</p> <ol style="list-style-type: none"> 1) Eco : This mode is optimized for small screens smaller than 100 inches. 	

This mode decreases the lamp brightness and power consumption in order to extend the lamp lifetime and reduce noise and power consumption.



- 2) **Bright** : This mode maximizes the lamp brightness when the ambient illumination is bright. As the brightness of the lamp increases, the lamp lifetime can be reduced and the noise and power consumption may increase.

V-Keystone

If video scenes are distorted or tilted, you can compensate for this using the vertical Keystone function.

- ▶ **The sound output of your projector is temporarily stopped while the keystone is being changed.**
- ▶ **The keystone is not compensated for in the On Screen Display (OSD).**



Background

You can set the Background that is displayed when there is no signal from the external device connected to the projector. If a signal is received, the Background you set disappears and a normal screen is displayed.

- 1) **Logo**
- 2) **Blue**
- 3) **Black**



Test Pattern

Generated by the projector itself. Utilized as standard to optimize the installation of the projector.

- 1) **Crosshatch** : You can check whether the picture is distorted or not.
- 2) **Screen Size** : You can refer to picture format sizes such as 1.33:1 or 1.78:1.



Video Type

Allows you to set the type of input signal when your projector fails to determine this automatically in PC mode.

- ▶ **In [PC] mode, this is only enabled if the input signal is AV Timing(D-Sub). However, for a separate H/V sync., this is only enabled for 1280 x 720p 59.94 Hz/60 Hz signals.**

- 1) **Auto**
- 2) **RGB(PC)**
- 3) **RGB(AV)**
- 4) **YPbPr(AV)**



	Usage	Color, Sharpness, Tint	PC menu and zoom
RGB(PC)	When connecting the RGB output of a PC to the D-Sub terminal	Disable	Enable
RGB(AV)	When connecting the RGB output of an AV device (STB, DVD, etc...) to the D-Sub terminal	Enable	Enable
YPbPr(AV)	When connecting the YPbPr output of an AV device (STB, DVD, etc...) to the D-Sub terminal	Enable	Disable
Auto	Auto settings	-	-

Reset

Using this function, you can reset various settings to the factory default settings.

- 1) **Factory Default** : Changes the settings to the factory defaults.
- 2) **Reset Filter Time** : Resets the filter time.





* Click the Play(▶)/Stop(■) button in the table below to view the video file.

Screen Adjustment	Description	Play/Stop
Language	You can select the Language used for the menu screen. 1) English 7) Svenska 2) Deutsch 8) Português 3) Nederlands 9) Русский 4) Español 10) 中国語 5) Français 11) 한국어 6) Italiano	
Menu Option	1) Position You can move Menu Position up/down/left/right. 2) Transparency You can set the translucency of menu. - Low - Medium - High - Opaque 3) Display Time You can set the display time of the menu. - 5 sec / 10 sec / 30 sec / 60 sec / 90 sec / 120 sec / Stay On	 Position Transparency Display Time
Sound	Adjusts the right and left audio balance and equalizer of the 3W stereo speaker embedded in the projector. 1) Balance 4) 1kHz 2) 100Hz 5) 3kHz 3) 300Hz 6) 10kHz	
Filter Check Time	Sets the check period for the filter. (Unit: hour) 1) Off 2) 100 3) 200 4) 400 5) 800 ▶ If the filter usage time is larger than the filter check period, the filter check message is displayed for a minute whenever the projector is turned on. ▶ Filter check message: "Check the filter, and if necessary, clean or replace it."	
Auto Power On	If the power is supplied to the projector, it is turned on automatically without pressing the Power button. 1) Off	

2) On

Sleep Timer

If there is no input signal for the specified time, the projector is turned off automatically.
(But, for the specified time, there must be no button input from the remote control or the top of the projector)

- 1) Off
- 2) 10 min
- 3) 20 min
- 4) 30 min



Information

You can check external source signals, picture setup, PC picture adjustment and lamp use time.



LCD PROJECTOR

SP-L250 SP-L220 SP-L200



Before Contacting Service Personnel

2 Installation and Connection

Symptoms	Troubleshooting
No Power.	<ul style="list-style-type: none"> Check the power cable connections.
I want to install my projector on the ceiling.	<ul style="list-style-type: none"> The ceiling installation support is sold separately. Contact your local product distributor.
External Source can not be selected.	<ul style="list-style-type: none"> Be sure that the connection cable(s) (video) is properly connected to the proper port. If the device is not connected properly, it can not be selected.

2 Menu and Remote Control

Symptoms	Troubleshooting
Remote control does not work.	<ul style="list-style-type: none"> Check whether your remote control is at a right angle and at the correct distance. Remove any obstacles between your remote control and the product. Direct lighting of 3-way light bulbs or other lighting device on the remote sensor of the projector may affect the sensitivity and cause the remote control to malfunction. Check if the remote control battery is empty. Check whether the LED indicator on the top of the projector is turned on.
I cannot select a menu.	<ul style="list-style-type: none"> Check if the menu is displayed in gray. A gray-colored menu is unavailable.

2 Screen and External Source

Symptoms	Troubleshooting
Cannot see picture images.	<ul style="list-style-type: none"> Be sure that the power cord of the projector is connected. Be sure that the proper input source is selected. Check that the connectors are properly connected to the ports at the back of the projector. Check the Remote Control batteries. Be sure that the <Color>, <Brightness> settings are not at their lower limit.
Poor color.	<ul style="list-style-type: none"> Adjust the <Tint> and <Contrast>.
Images are not clear.	<ul style="list-style-type: none"> Adjust the focus. Check that the projection distance is either too far or too near to the screen.
Strange noise.	<ul style="list-style-type: none"> If the strange sound continues, contact our service center.
The operating LED is lit up.	<ul style="list-style-type: none"> Refer to Corrective Actions According to LED Indications.
Lines appear on the screen.	<ul style="list-style-type: none"> Because noise may occur when using your PC, adjust the frequency of the screen.
No external device screen is displayed.	<ul style="list-style-type: none"> Check the operating status for the external device and check whether the adjustment items, such as the Brightness and the Contrast have been changed correctly in the <Mode> command screen of the Projector menu.
Only blue screen appears.	<ul style="list-style-type: none"> Be sure to properly connect the external devices. Check the connection cables again.
Screen is black and white or abnormal color/ screen is too dark or bright.	<ul style="list-style-type: none"> As mentioned above, check the adjustment items such as the Brightness, Contrast and Color in the menu.

- If you want to restore various settings to their factory defaults, run <Factory Default> from the menu.

LCD PROJECTOR
SP-L250 SP-L220 SP-L200



Care and Maintenance

2 To clean the exterior and lens of the projector

Clean the projector using a soft, dry cloth.

- ❖ Do not clean the projector with flammable substances such as benzene, thinners or a wet cloth, as these may cause problems.
- ❖ Do not touch the projector with a nail or any other sharp objects, as this may scratch the surface.



3 To clean the interior of the projector

For cleaning the interior of the projector, ask your Service Center or a distributor.

- ❖ Contact your distributor or a Service Center if dust or other substances are inside the projector.



4 Lamp Replacement

Cautions on Lamp Replacement

- ❖ The projector lamp is an expendable item. For best operating performance, replace the lamp according to the usage time. You can view the lamp usage time in the Information Display (INFO button).
- ❖ Use the recommended lamp when replacing. Replace the lamp with the one specified below.
 - Lamp Model Name : NSHA230SS
 - Lamp Manufacturer : Ushio
 - For inquiries on lamp purchase, please refer to '[Contact SAMSUNG WORLDWIDE](#)'.
- ❖ Check that the power cord is unplugged before replacing the lamp.
- ❖ Since the lamp is a high temperature and high voltage product, wait at least one hour from the time that the power cord is disconnected before replacing it.
- ❖ The lamp is located on the left side of the projector (when looking from the front).
- ❖ Do not leave the old lamp near inflammables or in reach of children. There is a danger of burn or injury.
- ❖ Remove dirt or foreign materials around or inside the lamp unit using a proper vacuum device.
- ❖ When handling the lamp, avoid touching any part of it except for the handles. If you handle the lamp incorrectly, it may affect the screen quality and shorten its lifetime.
- ❖ Before you turn the projector over to change the lamp, cover the projector with a soft cloth on a flat surface.

- ◇ The projector has been designed so that the projector does not work if the lamp cover is not completely assembled after a lamp replacement. If the projector does not work properly, **please check the operating status of the indicator LED.**

Contains Mercury, Dispose According to Local, State or Federal Laws

Lamp Replacement Procedure



- ◇ Since the lamp is a high temperature and high voltage product, wait at least one hour from the time that the power cord is disconnected before replacing it.

The lamp is located on the left side of the projector (when looking from the front).

- 1 Remove the screw shown in the figure below and then open the cover.
- 2 Remove the two (2) screws shown in the figure below.
- 3 Hold and pull the lamp handle out of the projector, as shown in the figure below.

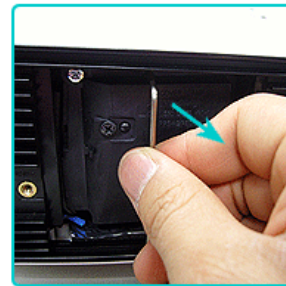
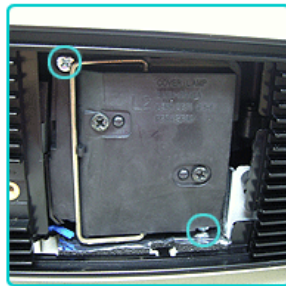
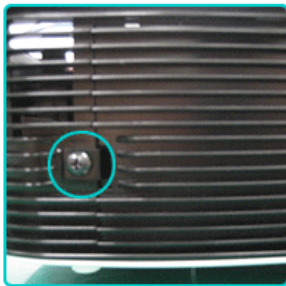

- ◇ Assembling a new lamp is in the reverse order of the disassembly.

➤ Replacing and Cleaning the Filter

Precautions when replacing the projector filter

- ◇ The filter is located at the bottom of the projector.
- ◇ Turn off the power of the projector, and then disconnect the power cord after the heat of the projector is cooled sufficiently. Otherwise, its parts may be damaged due to internal heat.
- ◇ When replacing the filter, dust may occur.
- ◇ For inquiries on filter purchase, please refer to '**Contact SAMSUNG WORLDWIDE**'.

The sequence for replacing or cleaning the filter of the projector.

- 1 Turn off the power of the projector, and then disconnect the power cord after the heat of the projector has cooled sufficiently.
- 2 Place the product so that its bottom looks upward, then push and remove the filter cover in the direction of the arrow.
- 3 Replace or clean the filter.

* When placing the product with the bottom upwards, make sure to place a soft cloth on the floor to prevent scratches.



- ◇ When cleaning the filter, use a small vacuum cleaner for computers and small electronics products, or wash it under running water.

- ❖ When washing the filter under running water, make sure to dry it completely. The moisture may cause the filter to corrode.
- ❖ If dust cannot be separated from the filter or the filter is torn, it must be replaced.
- ❖ Make sure to select the **Reset Filter Time** option after replacing or cleaning the filter of the projector.

➤ **Ventilating openings**

The location of the ventilation openings

- ❖ The ventilation openings are located on the right and left sides and at the bottom of the projector.



| [Care and Maintenance](#) | [Contact SAMSUNG WORLDWIDE](#) | [Authority](#) |

 **Contact SAMSUNG WORLDWIDE**

If you have any questions or comments relating to Samsung products, please contact a SAMSUNG customer care center.

North America		
U.S.A	1-800-SAMSUNG(726-7864)	http://www.samsung.com/us
CANADA	1-800-SAMSUNG(726-7864)	http://www.samsung.com/ca
MEXICO	01-800-SAMSUNG(726-7864)	http://www.samsung.com/mx

Latin America		
ARGENTINA	0800-333-3733	http://www.samsung.com/ar
BRAZIL	0800-124-421 4004-0000	http://www.samsung.com/br
CHILE	800-SAMSUNG(726-7864)	http://www.samsung.com/cl
COLOMBIA	01-8000112112	http://www.samsung.com/co
COSTA RICA	0-800-507-7267	http://www.samsung.com/latin
ECUADOR	1-800-10-7267	http://www.samsung.com/latin
EL SALVADOR	800-6225	http://www.samsung.com/latin
GUATEMALA	1-800-299-0013	http://www.samsung.com/latin
HONDURAS	800-7919267	http://www.samsung.com/latin
JAMAICA	1-800-234-7267	http://www.samsung.com/latin
NICARAGUA	00-1800-5077267	http://www.samsung.com/latin
PANAMA	800-7267	http://www.samsung.com/latin
PUERTO RICO	1-800-682-3180	http://www.samsung.com/latin
REP. DOMINICA	1-800-751-2676	http://www.samsung.com/latin
TRINIDAD & TOBAGO	1-800-SAMSUNG(726-7864)	http://www.samsung.com/latin
VENEZUELA	0-800-100-5303	http://www.samsung.com/latin

Europe

AUSTRIA	0810 - SAMSUNG(7267864, € 0.07/min)	http://www.samsung.com/at
BELGIUM	02 201 2418	http://www.samsung.com/be (Dutch) http://www.samsung.com/be_fr (French)
CZECH REPUBLIC	800 - SAMSUNG (800-726786)	http://www.samsung.com/cz
	Distributor pro Českou republiku: Samsung Zrt., česká organizační složka, Oasis Florenc, Sokolovská394/17, 180 00, Praha 8	
DENMARK	8 - SAMSUNG(7267864)	http://www.samsung.com/dk
EIRE	0818 717 100	http://www.samsung.com/ie
FINLAND	30 - 6227 515	http://www.samsung.com/fi
FRANCE	3260 dites 'SAMSUNG'(€ 0,15/Min) 0825 08 65 65 (€ 0.15/Min)	http://www.samsung.com/fr
GERMANY	01805 - SAMSUNG (7267864, € 0.14/Min)	http://www.samsung.de
HUNGARY	06-80-SAMSUNG (726-7864)	http://www.samsung.com/hu
ITALIA	800-SAMSUNG (726-7864)	http://www.samsung.com/it
LUXEMBURG	02 261 03 710	http://www.samsung.com/lu
NETHERLANDS	0900-SAMSUNG (0900-7267864) (€ 0,10/Min)	http://www.samsung.com/nl
NORWAY	3 - SAMSUNG(7267864)	http://www.samsung.com/no
POLAND	0 801 1SAMSUNG(172678) 022 - 607 - 93 - 33	http://www.samsung.com/pl
PORTUGAL	808 20 - SAMSUNG (7267864)	http://www.samsung.com/pt
SLOVAKIA	0800-SAMSUNG (726-7864)	http://www.samsung.com/sk
SPAIN	902 - 1 - SAMSUNG (902 172 678)	http://www.samsung.com/es
SWEDEN	075 - SAMSUNG(726 78 64)	http://www.samsung.com/se
SWITZERLAND	0848 - SAMSUNG(7267864, CHF 0.08/min)	http://www.samsung.com/ch
U.K	0845 SAMSUNG (7267864)	http://www.samsung.com/uk

CIS

ESTONIA	800-7267	http://www.samsung.com/ee
LATVIA	8000-7267	http://www.samsung.com/lv
LITHUANIA	8-800-77777	http://www.samsung.com/lt
KAZAKHSTAN	8-10-800-500-55-500	http://www.samsung.com/kz_ru
KYRGYZSTAN	00-800-500-55-500	
RUSSIA	8-800-555-55-55	http://www.samsung.ru
TADJIKISTAN	8-10-800-500-55-500	
UKRAINE	8-800-502-0000	http://www.samsung.ua
UZBEKISTAN	8-10-800-500-55-500	http://www.samsung.com/kz_ru

Asia Pacific

AUSTRALIA	1300 362 603 800-810-5858	http://www.samsung.com/au
CHINA	400-810-5858 010-6475 1880	http://www.samsung.com/cn
HONG KONG:	3698 - 4698	http://www.samsung.com/hk
INDIA	3030 8282 1-800-3000-8282	http://www.samsung.com/in
INDONESIA	1800 110011 0800-112-8888	http://www.samsung.com/id
JAPAN	0120-327-527	http://www.samsung.com/jp
MALAYSIA	1800-88-9999	http://www.samsung.com/my
NEW ZEALAND	0800 SAMSUNG (0800 726 786) 1-800-10-SAMSUNG(726-7864)	http://www.samsung.com/nz
PHILIPPINES	1-800-3-SAMSUNG(726-7864) 02-5805777	http://www.samsung.com/ph
SINGAPORE	1800-SAMSUNG(726-7864)	http://www.samsung.com/sg
THAILAND	1800-29-3232, 02-689-3232	http://www.samsung.com/th
TAIWAN	0800-329-999	http://www.samsung.com/tw
VIETNAM	1 800 588 889	http://www.samsung.com/vn

Middle East & Africa		
SOUTH AFRICA	0860-SAMSUNG(726-7864)	http://www.samsung.com/za
TURKEY	444 77 11	http://www.samsung.com/tr
U.A.E	800-SAMSUNG(726-7864) 8000-4726	http://www.samsung.com/ae

..... | [Care and Maintenance](#) | [Contact SAMSUNG WORLDWIDE](#) | [Authority](#) |



Information in this document is subject to change without notice.

© 2009 Samsung Electronics Co., Ltd. All rights reserved.

Reproduction in any manner whatsoever without the written permission of Samsung Electronics Co., Ltd. is strictly forbidden.

Samsung Electronics Co., Ltd. shall not be liable for errors contained herein or for incidental or consequential damages in connection with the furnishing, performance, or use of this material.

LCD PROJECTOR

SP-L250 SP-L220 SP-L200

